

Protected Fluorescent

V2 Specification  
Vaporlume LED

Wet Location Industrial 4'

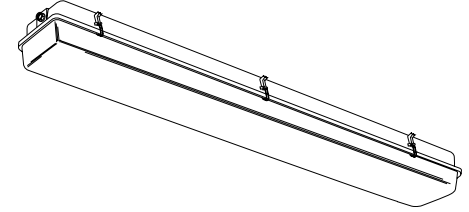

Specifier's Reference

Project
Type
Model No.
Comments

application

- Acceptable for outdoor as well as indoor installations.
- Can be surface (wall/ceiling) or suspended mounted unless otherwise specified.
- **Wet Location**-Areas of high humidity, water vapor, rain, incidental water spray, or other non-corrosive or non-flammable liquid.
- **Mounting brackets available, order separately.**
- IP65 rating standard. IP67 configuration available.
- LED sources provide excellent low temperature performance. This product can replace a fluorescent model in cold environments with significant energy savings.
- 2300 lumen model listed for use in 40°C ambient, other models listed for 25°C ambient.

construction/finish

- Non-conductive, non-corrosive housing.
- Smooth exterior surface for easy cleaning.
- White one piece, molded fiberglass reinforced polyester body. No rusting, no oxidation, and no corrosion.
- Lens formed from crepe pattern high-impact acrylic sheet of .130" nominal thickness.
- Continuous compressible closed cell gasket provides tight seal between plastic enclosure and luminaire body.
- Stainless Steel cam action latches.
- Lighting channel painted after fabrication with polyester powder coating.
- Two gasketed threaded (1/2" trade size) wet location hubs installed on ends.

electrical

- Five-year luminaire warranty including LED boards and driver.
- High efficiency LEDs have 50,000 hour rated life (L70, defined as 70% lumen maintenance).
- Driver and LED boards are accessible from below. LED boards are individually replaceable if required.
- Combinations are available providing as much as 96 delivered lumens per Watt.
- Lumen packages range from 2,300 to 5,100 lumens, providing flexibility to optimize light levels for a specific application.
- LED sources provide full illumination in low temperature applications, unlike fluorescent sources that provide reduced light levels in very cold environments.
- LED sources can be frequently switched with no negative impact on life.
- High CRI source provides excellent color rendering.
- Light output from the luminaire contains no infrared or ultraviolet energy, so the light won't heat or fade the objects being lit.
- Available motion sensor further increases energy savings in areas where occupancy is not continuous.
- ETL listed to UL standards.

accessories

- **TBK** – Stainless Steel Top Bracket Kit (pair of brackets plus hardware)
- **EBK** – Stainless Steel End Bracket Kit (pair of brackets plus hardware)
- **WBK** – Stainless Steel Wraparound Bracket Kit (pair of brackets)
- **FKR-126** – Chain Hanger Set (requires TBK)
- **TPDTH** – Tamperproof driver, Torx head pin drive (required with TR option)

Green Choice: V2WAE35L840-4-UNV-MD360W

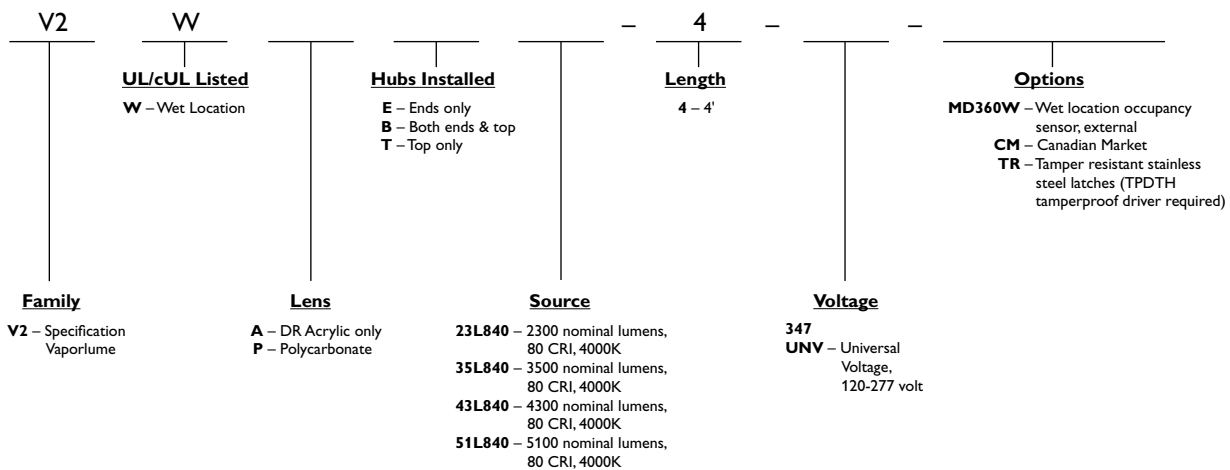

## energy data

Model	Initial Delivered Lumens @ 25°C Ambient	Input Power	Lumens per Watt	Application notes
V2WAE23L840-4-UNV	2,319	26W	89 LPW	<ul style="list-style-type: none"> <li>Equivalent to 1-lamp F32T8 at room temperature, 15% energy savings.</li> <li>Equivalent to 2-lamp F32T8 in freezer (25°F), 50% energy savings.</li> </ul>
V2WAE35L840-4-UNV	3,461	36W	96 LPW	<ul style="list-style-type: none"> <li>Slightly less than 2-lamp F32T8 at room temperature, 35% energy savings.</li> <li>Equivalent to 2-lamp F32T8 in refrigerator (40°F), 35% energy savings.</li> </ul>
V2WAE43L840-4-UNV	4,346	49W	89 LPW	<ul style="list-style-type: none"> <li>Equivalent to 2-lamp F32T8 at room temperature, 15% energy savings.</li> <li>Double the output of 2-lamp F32T8 in freezer (25°F) at the SAME energy use.</li> </ul>
V2WAE51L840-4-UNV	5,121	59W	87 LPW	<ul style="list-style-type: none"> <li>Equivalent to high ballast factor 2-lamp F32T8 at room temperature, 15% energy savings.</li> </ul>

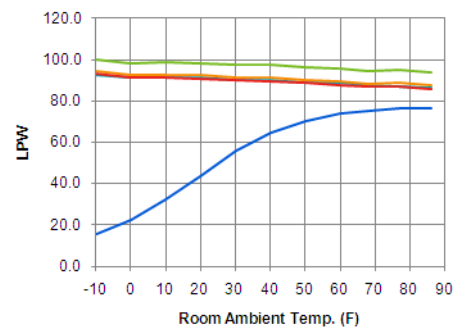
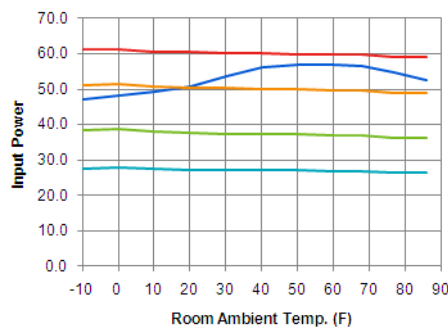
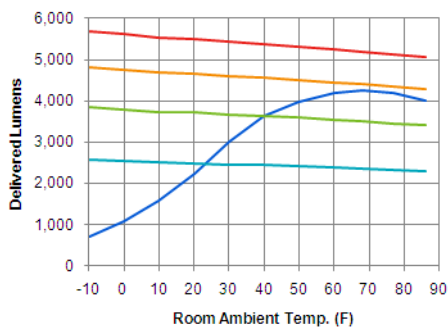

— 2-LAMP F32T8 — V2WAE23L840 — V2WAE35L840  
— V2WAE43L840 — V2WAE51L840

— 2-LAMP F32T8 — V2WAE23L840 — V2WAE35L840  
— V2WAE43L840 — V2WAE51L840

— 2-LAMP F32T8 — V2WAE23L840 — V2WAE35L840  
— V2WAE43L840 — V2WAE51L840

## dimensions

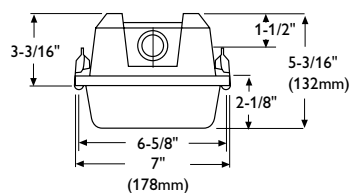
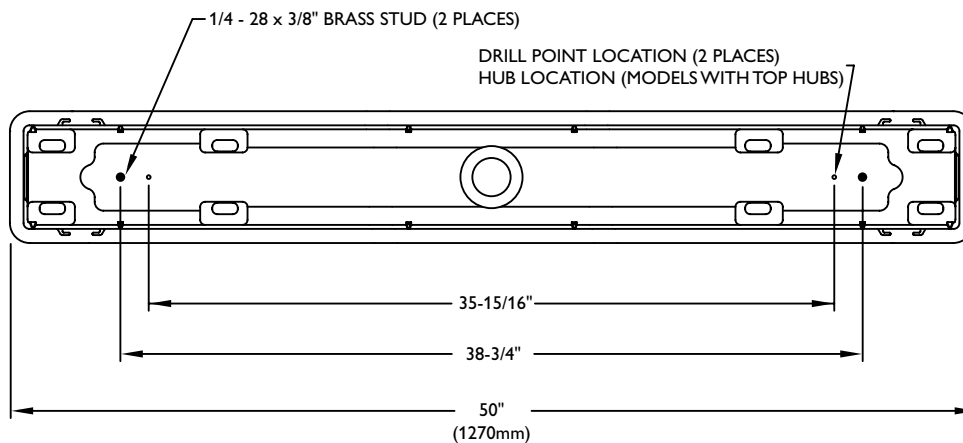

## mounting brackets

**TBK - Top Mounting Bracket**

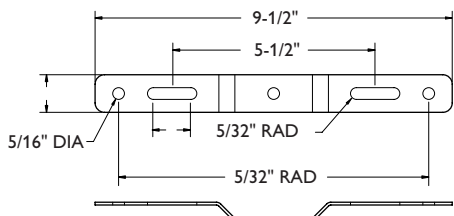

**WBK - Wraparound Mounting Bracket**

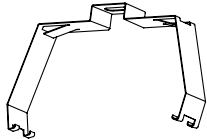

**EBK - End Mounting Bracket**

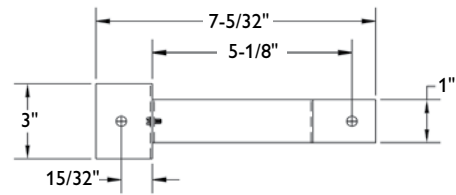

**EBK - End Mounting Bracket**

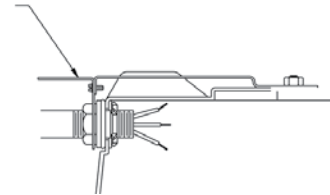

## photometry

### 4' LED Vaporlume

**Delivered Lumens – 2319**

**LER – 89**

Catalog No.	V2WAE23L840-4	Candlepower				Light Distribution			Average Luminance			
		Angle	End	45	Cross	Degrees	Lumens	% Luminaire	Angle	End	45°	Cross
<b>Test No.</b>	LTL23325D1	0	803	803	803	0-30	628	27.0	45	4192	3318	3082
<b>S/MH</b>	1.2	5	801	803	803	0-40	1024	44.1	55	3727	2790	2782
<b>Source</b>	LED	15	775	771	784	0-60	1781	76.7	65	3038	2501	2315
<b>Input Watts</b>	26	25	724	726	718	0-90	2279	98.1	75	2287	1784	1563
		35	647	630	627	0-180	2319	100.0	85	1199	788	625
		45	531	519	512							
		55	389	388	417							
		65	240	294	300							
		75	118	165	164							
		85	26	51	48							
		95	9	15	13							
		105	6	13	10							
		115	2	12	8							
		125	0	9	9							
		135	0	4	8							
		145	0	0	3							
		155	0	0	0							
		165	0	0	0							
		175	0	0	0							

Coefficients of Utilization												
EFFECTIVE FLOOR CAVITY REFLECTANCE 20 PER (pfc=0.20)												
pcc	80			70			50					
pw	70	50	30	70	50	30	70	50	30	50	30	
RCR												
0	118	118	118	115	115	115	110	110	110	110	110	
1	108	103	98	105	101	96	95	93	93	93	93	
2	97	90	82	94	88	81	83	79	79	79	79	
3	90	79	70	86	77	69	73	67	67	67	67	
4	81	69	60	79	68	59	66	58	58	58	58	
5	75	61	53	72	60	53	58	51	51	51	51	
6	69	56	46	68	55	46	53	46	46	46	46	
7	65	51	41	63	50	41	47	40	40	40	40	
8	59	46	38	57	46	38	44	36	36	36	36	
9	56	42	34	55	41	34	40	33	33	33	33	
10	53	39	30	51	39	30	38	30	30	30	30	

Catalog No.	V2WAE35L840-4	Candlepower				Light Distribution			Average Luminance			
		Angle	End	45	Cross	Degrees	Lumens	% Luminaire	Angle	End	45°	Cross
<b>Test No.</b>	LTL23329D1	0	1201	1201	1201	0-30	929	26.8	45	6298	4918	4752
<b>S/MH</b>	1.2	5	1191	1190	1184	0-40	1520	43.9	55	5635	4220	4130
<b>Source</b>	LED	15	1153	1153	1149	0-60	2651	76.5	65	4608	3639	3559
<b>Input Watts</b>	36	25	1081	1067	1050	0-90	3393	98.0	75	3422	2832	2418
		35	963	926	933	0-180	3461	100.0	85	1799	1231	942
		45	798	770	789							
		55	589	587	620							
		65	365	427	461							
		75	176	261	254							
		85	40	79	73							
		95	14	25	22							
		105	10	24	17							
		115	3	20	15							
		125	0	11	14							
		135	0	4	9							
		145	0	0	3							
		155	0	0	0							
		165	0	0	0							
		175	0	0	0							

Coefficients of Utilization												
EFFECTIVE FLOOR CAVITY REFLECTANCE 20 PER (pfc=0.20)												
pcc	80			70			50					
pw	70	50	30	70	50	30	70	50	30	50	30	
RCR												
0	118	118	118	115	115	115	110	110	110	110	110	
1	108	103	98	105	101	96	95	93	93	93	93	
2	97	90	82	94	88	81	83	78	78	78	78	
3	89	79	70	86	77	68	73	67	67	67	67	
4	81	69	60	79	68	59	66	57	57	57	57	
5	75	61	53	72	60	53	58	51	51	51	51	
6	69	56	46	67	55	46	53	46	46	46	46	
7	64	51	41	63	50	41	47	40	40	40	40	
8	59	46	38	57	46	38	44	36	36	36	36	
9	56	42	34	55	41	34	40	33	33	33	33	
10	53	39	30	51	39	30	38	30	30	30	30	

### 4' LED Vaporlume

**Delivered Lumens – 3461**

**LER – 96**

Catalog No.	V2WAE35L840-4	Candlepower				Light Distribution			Average Luminance			
		Angle	End	45	Cross	Degrees	Lumens	% Luminaire	Angle	End	45°	Cross
<b>Test No.</b>	LTL23329D1	0	1201	1201	1201	0-30	929	26.8	45	6298	4918	4752
<b>S/MH</b>	1.2	5	1191	1190	1184	0-40	1520	43.9	55	5635	4220	4130
<b>Source</b>	LED	15	1153	1153	1149	0-60	2651	76.5	65	4608	3639	3559
<b>Input Watts</b>	36	25	1081	1067	1050	0-90	3393	98.0	75	3422	2832	2418
		35	963	926	933	0-180	3461	100.0	85	1799	1231	942
		45	798	770	789							
		55	589	587	620							
		65	365	427	461							
		75	176	261	254							
		85	40	79	73							
		95	14	25	22							
		105	10	24	17							
		115	3	20	15							
		125	0	11	14							
		135	0	4	9							
		145	0	0	3							
		155	0	0	0							
		165	0	0	0							
		175	0	0	0							

Coefficients of Utilization												
EFFECTIVE FLOOR CAVITY REFLECTANCE 20 PER (pfc=0.20)												
pcc	80			70			50					
pw	70	50	30	70	50	30	70	50	30	50	30	
RCR												
0	118	118	118	115	115	115	110	110	110	110	110	
1	108	103	98	105	101	96	95	93	93	93	93	
2	97	90	82	94	88	81	83	78	78	78	78	
3	89	79	70	86	77	68	73	67	67	67	67	
4	81	69	60	79	68	59	66	57	57	57	57	
5	75	61	53	72	60	53	58	51	51	51	51	
6	69	56	46	67	55	46	53	46	46	46	46	
7	64	51	41	63	50	41	47	40	40	40	40	
8	59	46	38	57	46	38	44	36	36	36	36	
9	56	42	34	55	41	34	40	33	33	33	33	
10	53	39	30	51	39	30	38	30	30	30	30	

photometry

4' LED Vaporlume

Delivered Lumens – 4346

LER – 89

<b>Catalog No.</b> V2WAE43L840-4	<b>Test No.</b> LTL23327D1	<b>S/MH</b> 1.2	<b>Source</b> LED	<b>Input Watts</b> 49	<b>Candlepower</b>				<b>Light Distribution</b>			<b>Average Luminance</b>			
					<b>Angle</b>	<b>End</b>	<b>45</b>	<b>Cross</b>	<b>Degrees</b>	<b>Lumens</b>	<b>% Luminaire</b>	<b>Angle</b>	<b>End</b>	<b>45°</b>	<b>Cross</b>
Comparative yearly lighting energy cost per 1000 lumens – <b>\$2.70</b> based on 3000 hrs. and \$.08 pwr KWH.  Photometric values based upon tests performed in compliance with LM-79.					0	1515	1515	1515	0-30	1167	26.8	45	7944	6183	5985
					5	1499	1496	1491	(0-40)	1909	43.9	55	7104	5344	5277
					15	1451	1444	1450	(0-60)	3336	76.7	65	5811	4617	4468
					25	1359	1339	1316	0-90	4266	98.1	75	4282	3542	2983
					35	1211	1165	1177	0-180	4346	100.0	85	2216	1470	1084
					45	1006	968	993	<b>Coefficients of Utilization</b>						
					55	742	743	792	<b>EFFECTIVE FLOOR CAVITY REFLECTANCE 20 PER (pfc=0.20)</b>						
					65	460	542	579	pcc						
					75	220	327	314	pw						
					85	49	94	84	RCR						
					95	18	29	24	0						
					105	13	28	20	1						
					115	4	23	18	2						
					125	0	13	16	3						
					135	0	4	11	4						
					145	0	0	4	5						
					155	0	0	0	6						
165	0	0	0	7											
175	0	0	0	8											
				9											
				10											

4' LED Vaporlume

Delivered Lumens – 5121

LER – 87

<b>Catalog No.</b> V2WAE51L840-4	<b>Test No.</b> LTL23331D1	<b>S/MH</b> 1.2	<b>Source</b> LED	<b>Input Watts</b> 59	<b>Candlepower</b>				<b>Light Distribution</b>			<b>Average Luminance</b>			
					<b>Angle</b>	<b>End</b>	<b>45</b>	<b>Cross</b>	<b>Degrees</b>	<b>Lumens</b>	<b>% Luminaire</b>	<b>Angle</b>	<b>End</b>	<b>45°</b>	<b>Cross</b>
Comparative yearly lighting energy cost per 1000 lumens – <b>\$2.76</b> based on 3000 hrs. and \$.08 pwr KWH.  Photometric values based upon tests performed in compliance with LM-79.					0	1785	1785	1785	0-30	1375	26.8	45	9310	7277	7038
					5	1754	1757	1753	0-40	2249	43.9	55	8317	6239	6147
					15	1708	1701	1704	0-60	3923	76.5	65	6820	5389	5252
					25	1601	1581	1554	0-90	5021	98.0	75	5047	4186	3572
					35	1426	1372	1383	0-180	5121	100.0	85	2660	1816	1389
					45	1179	1139	1168	<b>Coefficients of Utilization</b>						
					55	869	868	922	<b>EFFECTIVE FLOOR CAVITY REFLECTANCE 20 PER (pfc=0.20)</b>						
					65	540	633	680	pcc						
					75	259	386	375	pw						
					85	59	117	108	RCR						
					95	21	37	32	0						
					105	15	35	25	1						
					115	5	29	23	2						
					125	0	17	21	3						
					135	0	6	14	4						
					145	0	0	4	5						
					155	0	0	0	6						
165	0	0	0	7											
175	0	0	0	8											
				9											
				10											



©2011 Philips Day-Brite  
All rights reserved.

776 South Green Street • Tupelo, MS 38804  
p. 800.234.1890 • f. 662.841.5501  
Canadian Division  
189 Bullock Drive • Markham, Ontario L3P 1W4  
p. 905.294.9570 • f. 905.294.9811

Contact Factory for Additional Configurations.  
Specifications are subject to change without notice.